

SOLCA L

Solární LED svítidlo

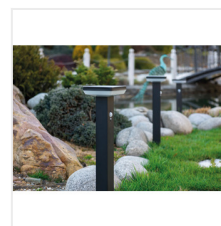
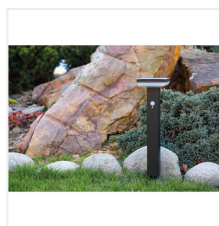
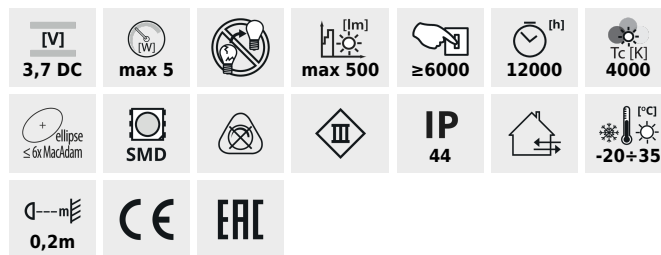

		$[W]$	$[lm]$	$T_c [K]$		
SOLCA L PV EL-B	25774	max 5	max 500	4000	k usazení na zeď	černá
SOLCA L PV 50-B	25775	max 5	max 500	4000	k usazení na zem	černá
SOLCA L PV 50 SPI-B	25776	max 5	max 500	4000	do země	černá

Kanlux SOLCA L jsou zahradní solární svítidla s hranatými stínidly, které jsou nezávislé na elektrické instalaci. Díky tomu máme větší svobodu v jejich umístování. Dalšími výhodami svítidel Kanlux SOLCA L je rychlá a jednoduchá instalace a úspora elektrické energie. Svítidla Kanlux SOLCA L mohou pracovat ve 3 různých režimech a jsou také vybavena senzorem pohybu.

- Materiál korpusu: ocel
- Materiál difuzoru: plast

SOLCA L

Solární LED svítidlo



SOLCA L PV EL-B

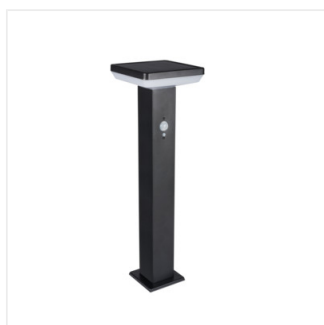

SOLCA L PV 50-B



SOLCA L PV 50 SPI-B

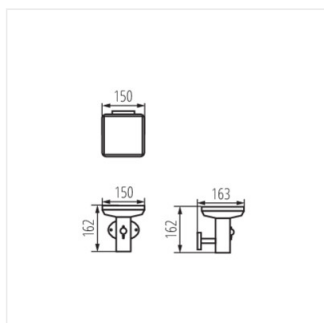

SOLCA L PV EL-B

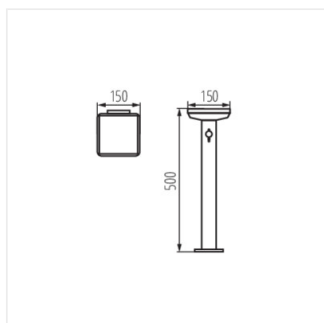

SOLCA L PV 50-B

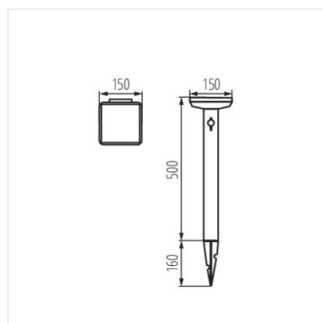





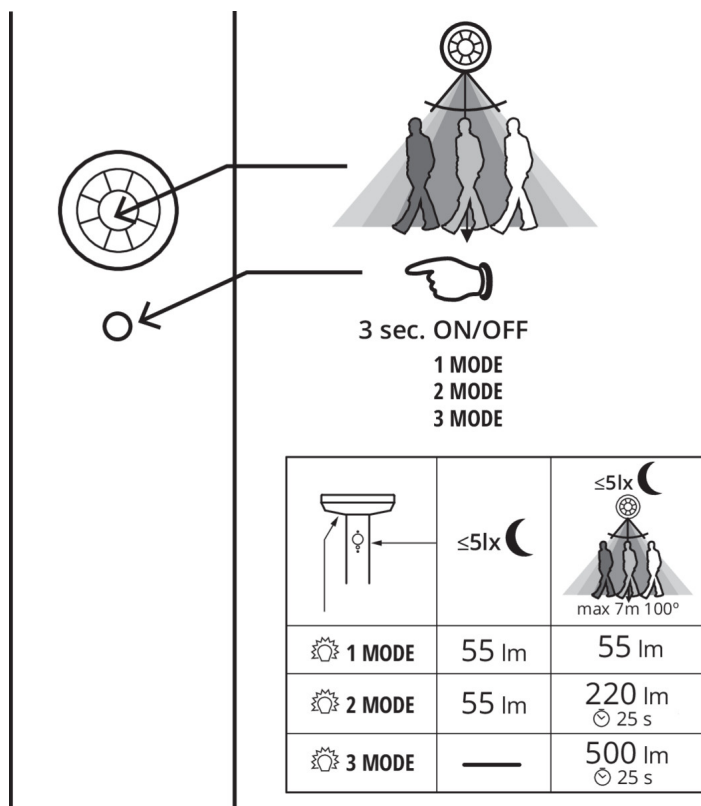

SOLCA L PV 50 SPI-B

SOLCA L

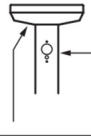
Solární LED svítidlo



3 sec. ON/OFF
1 MODE
2 MODE
3 MODE

	$\leq 51x$ 	$\leq 51x$  max 7m 100°
 1 MODE	55 lm	55 lm
 2 MODE	55 lm	220 lm ☀ 25 s
 3 MODE	—	500 lm ☀ 25 s