

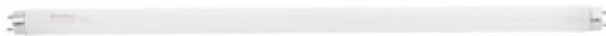





Lineární zářivka



T8 18W/840 NW

						
T8 18W/840 NW	19921	18	1350	4000	G13	A
T8 18W/865 CW	19922	18	1250	6500	G13	A
T8 36W/840 NW	19924	36	3350	4000	G13	A+
T8 36W/865 CW	19925	36	3050	6500	G13	A
T8 58W/840 NW	19927	58	5250	4000	G13	A+
T8 58W/865 CW	19928	58	5000	6500	G13	A

Kanlux T8 jsou třípásmové lineární zářivky. Nízká spotřeba energie a dlouhá doba svícení (15 000 H) jsou nepochybně výhodou těchto žárovek.

- Materiál: sklo

T8

Lineární zářivka

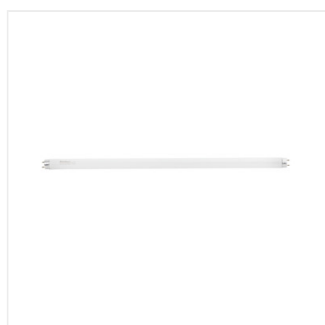

T8 36W

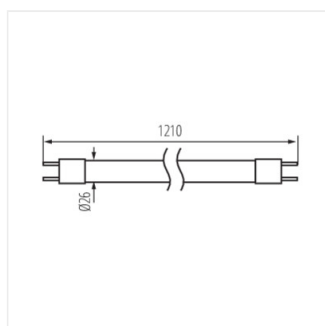

T8 36W-840