







[Hz] 50/60	CC 	PRI [V] 220-240	SEC [V] 0,5-10 DC	SEC [mA] 350		IP 20
			[mm ²] 0,75	[m] 0,1		
EAC						



ADI 350 1x3W



ADI 350 1x3W	01440	220-240 AC	1-3
ADI 350 1x3W P	23870	220-240 AC	1-3

- ADI 350 1-3W stabilizovaný proud 350mA DC
- maximální povolená teplota pouzdra 75°C
- tepelná pojistka vypínající transformátor při překročení teploty 110°C
- vestavěná ochrana proti zkratu a přetížení
- Materiál: plast



ADI 350 1x3W



ADI 350 1x3W P

ADI

Napaječ CC

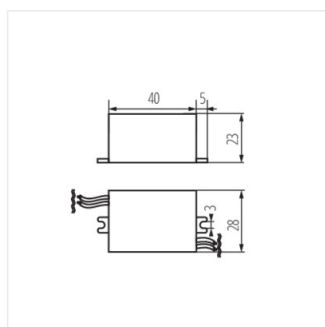

ADI 350 1x3W